

**BOGONI ALUMÍNIOS**

**PERFIS NOVEIS**

**2017**

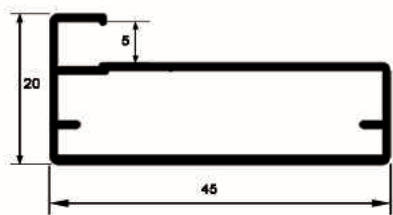

MV-116  
2,300kg/BR

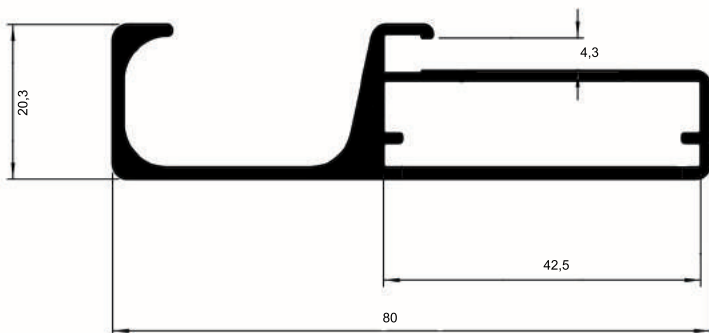

MV-204  
5,130kg/BR

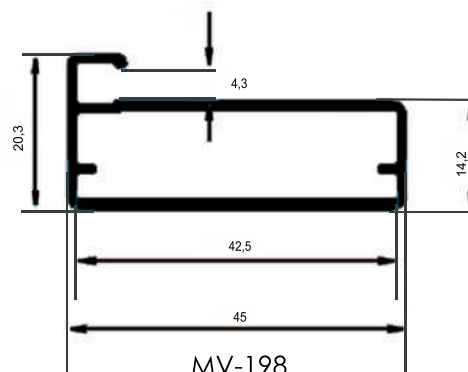

MV-198  
2,780kg/BR

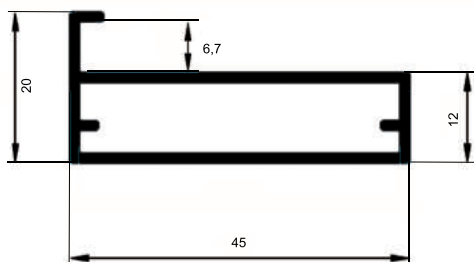

MV-062  
2,670kg/BR

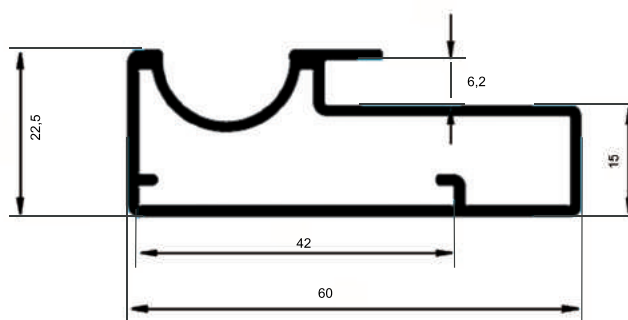

MV-003  
4,010kg/BR

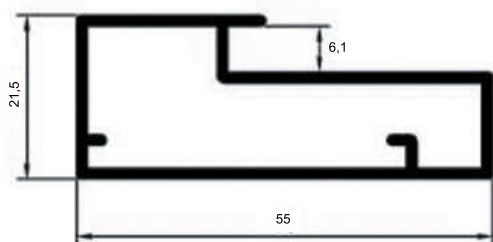

MV-020  
4,100kg/BR

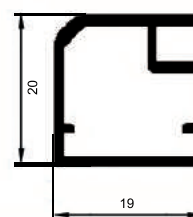

MV-237  
1,650kg/BR

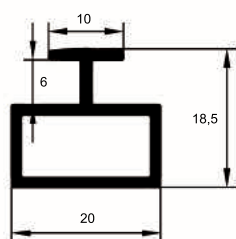

MV-019  
1,650kg/BR

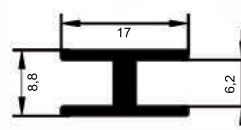

MV-246  
1,070kg/BR

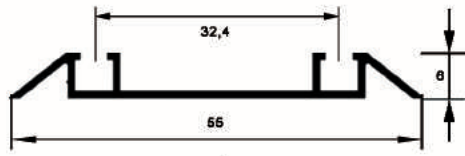

**MV-477**  
1,410kg/BR

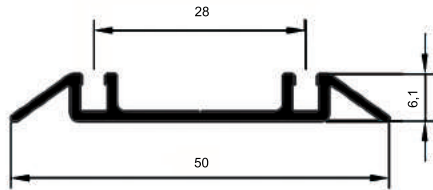

**MV-037**  
1,480kg/BR

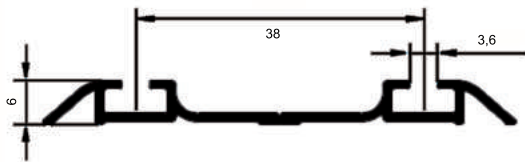

**MV-051**  
1,950kg/BR

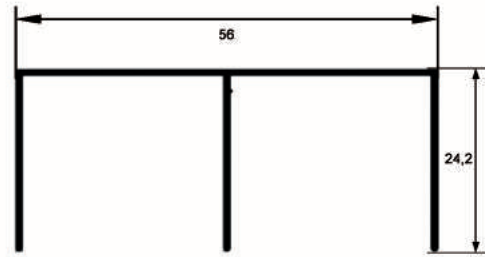

**MV-474**  
1,910kg/BR

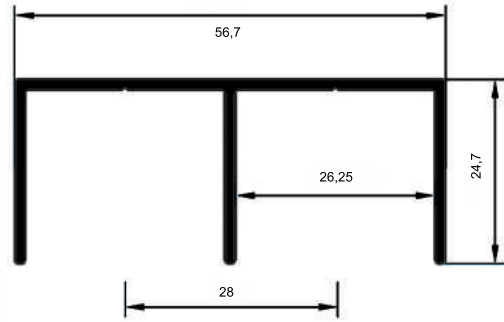

**MV-036**  
2,880kg/BR

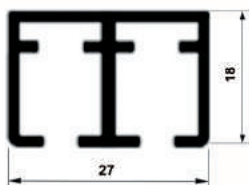

**MVTS-10**  
1,900kg/BR

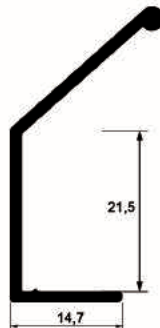

**MV-090**  
1,270kg/BR

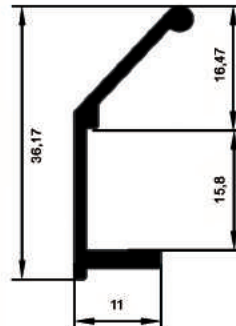

**MV-203**  
1,560kg/BR

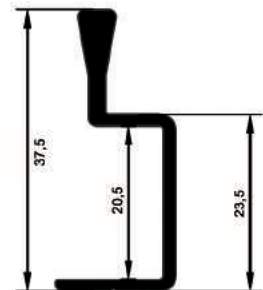

**MV-239**  
1,790kg/BR

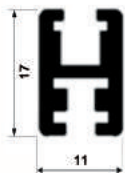

**MVPP-10**  
1,490kg/BR

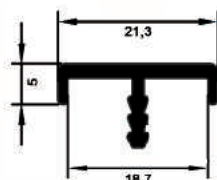

**MV-241**  
1,040kg/BR

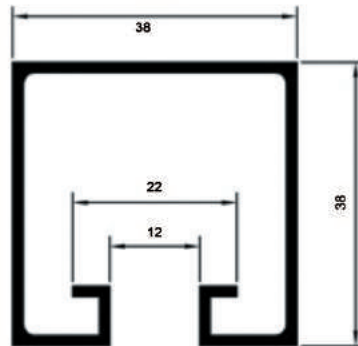

**DS-544**  
3,550kg/BR

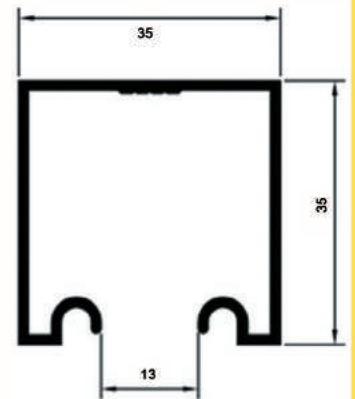

**DS-266**  
2,900kg/BR

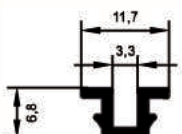

**MV-055**  
0,600kg/BR

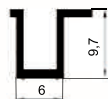

**MV-033**  
0,550kg/BR

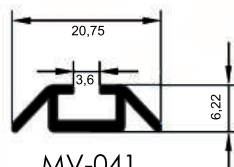

**MV-041**  
0,750kg/BR

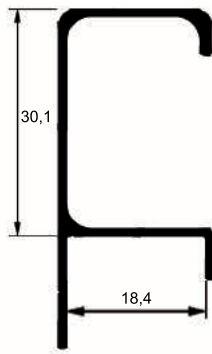

MV-005  
1,76kg/BR

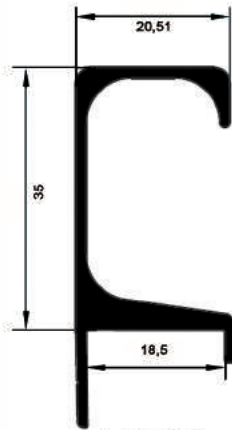

MV-202  
3,110kg/BR

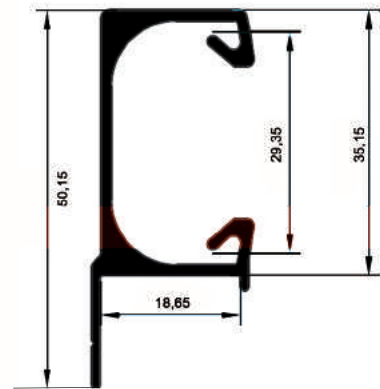

MV-275  
3,080kg/BR

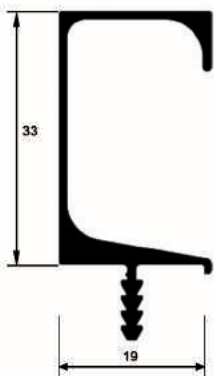

MV-468  
2,200kg/BR



MV-142  
2,990kg/BR

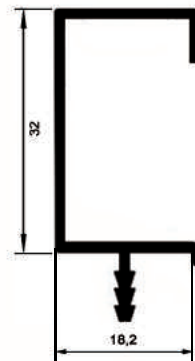

MV-1041  
2,500kg/BR

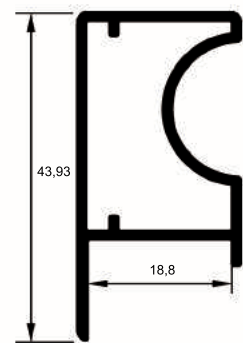

MV-102  
2,800kg/BR

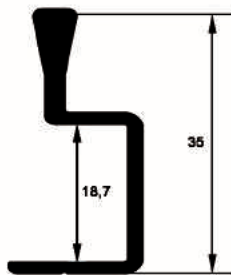

MV-519  
1,700kg/BR

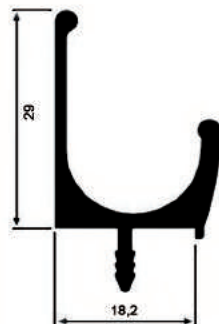

MV-1066  
2,65kg/BR

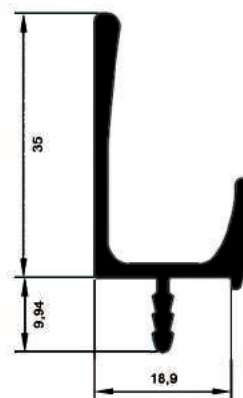

MV-022  
2,360kg/BR

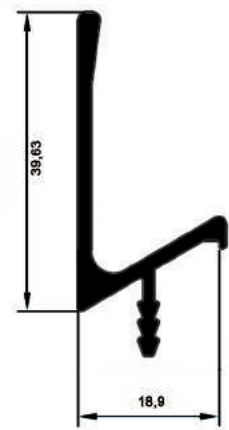

MV-094  
2,360kg/BR

